

THE  
*Signature*  
COLLECTION™  
WINDOWS & DOORS  
WITH EXTENDED WARRANTIES

An **extended warranty scheme** direct to the homeowner for added customer confidence

# Product Guide

- Casement Windows
- Tilt and Turn Windows
- Flush Sash Windows
- Bi-Folding Doors
- Patio Doors
- French Doors
- Residential Doors
- Conservatories



**Fenestration**



# Pearl Window Systems Installer Scheme

10 YEARS <sup>TM</sup> GUARANTEED MECHANICAL WARRANTY	10 YEARS <sup>TM</sup> GUARANTEED MECHANICAL WARRANTY	10 YEARS <sup>TM</sup> GUARANTEED MECHANICAL WARRANTY	10 YEARS <sup>TM</sup> GUARANTEED MECHANICAL WARRANTY	LIFETIME <sup>TM</sup> GUARANTEED COATING WARRANTY	LIFETIME <sup>TM</sup> GUARANTEED COATING WARRANTY
<b>Casement Windows</b>	<b>Tilt and Turn Windows</b>	<b>Single and French Residential Doors</b>	<b>Composite Doors</b>	<b>Single and French Residential Doors</b>	<b>Composite Doors</b>
<b>10 Years Mechanical Warranty on:</b>	<b>10 Years Mechanical Warranty on:</b>	<b>10 Years Mechanical Warranty on:</b>	<b>10 Years Mechanical Warranty on:</b>	<b>Lifetime Coating Warranty on:</b>	<b>Lifetime Coating Warranty on:</b>
<ul style="list-style-type: none"> <li>• Friction Stays</li> <li>• Window Handles</li> <li>• Sentinel Easy Fit Locking Mechanisms</li> </ul>	<ul style="list-style-type: none"> <li>• Tilt and Turn Mechanisms</li> <li>• Tilt and Turn Hinges</li> <li>• Tilt and Turn Handles</li> </ul>	<ul style="list-style-type: none"> <li>• Door Locks</li> <li>• Cylinders</li> <li>• Door Handles</li> <li>• Pro Secure Door Hinges</li> </ul>	<ul style="list-style-type: none"> <li>• Door Locks</li> <li>• Cylinders</li> <li>• Door Handles</li> <li>• Composite Door Hinges</li> </ul>	<ul style="list-style-type: none"> <li>• Marine Grade Stainless Steel Gold and Chrome Door Handles</li> <li>• Marine Grade Stainless Steel Gold and Chrome Letter Plates</li> </ul>	<ul style="list-style-type: none"> <li>• Marine Grade Stainless Steel Gold and Chrome Door Handles</li> <li>• Marine Grade Stainless Steel Gold and Chrome Letter Plates</li> </ul>

As well as the usual product guarantees, Pearl offer a free extended hardware warranty which is registered direct with the manufacturer.

Pearl will supply its customers with marketing materials including a Homeowner handbook which gives instructions for the occupier for the ongoing maintenance of the products.

Pearl approval of their customers includes the head office requirements for CORGI Fenestration meaning only an onsite audit needs to be conducted by CORGI Fenestration.

Pearl customers no longer need to purchase IBG's as CORGI Fenestration issues a workmanship warranty providing financial protection to your clients which is included in the notification fee.

CORGI Fenestration does not conduct a 1% sample of installations rather they use a risk-based analysis, called The Quality Standards Indicator, which calculates what level of installation inspections is required.

Notification with CORGI Fenestration includes RateYourInstallation, all aspects of an installation can be rated. Costs are included in your notification fee.

Pearl customers will be able to self-certify / notify their installations directly with Pearl.

CORGI Fenestration will issue an installation certificate to the consumer covering all the work carried out, not only the replacement windows.



All warranties are subject to contract approval and in conjunction with Pearl Window Systems terms and conditions of sale.

All marketing is as per the latest pricing matrix.

## Pearl Installer Scheme Benefits:

- Working with a leading super fabricator supplying quality products
- Pearl marketing support package
- Unique extended hardware warranty
- Remedials registered direct with the suppliers reducing call outs
- RateYourInstallation, a 'TripAdvisor' type consumer ratings service. Allows homeowners to choose installers independently rated by other satisfied customers providing a valuable installer marketing tool.
- Reduced site inspections
- Reduced CORGI Fenestration scheme costs
- Use of the CORGI Fenestration logo
- No IBG costs
- One notification fee covering all products installed
- Automatic building compliance notification for replacement windows and doors
- All via PEARL installer Portal



# Contents

4	Casement Windows	20	Residential Doors
6	Flush Sash Windows	22	Stable Doors
8	Bi-Fold Windows	24	Standard Bi-Fold Doors
10	Tilt and Turn Windows	26	ModLok™ Bi-Folding Doors
12	French Windows	28	ModLok™ Patio Doors
14	Bow and Bay Windows	30	Alumina Bi-Fold Doors
16	French Doors	32	Conservatory Roofs
18	Composite Doors	34	Elevate Lanterns



CONTENTS

# Casement Windows



## Why choose... *The Signature Collection* Casement Windows?

The Signature Collection casement windows offer total versatility with traditional British style offering slim sightlines to let in maximum light to brighten your home.

### KEEP HEAT INSIDE

With a standard four chamber or unique six chamber PVCu profile, EnergyPlus can easily achieve an A+ rating, helping you to contain and conserve heat within your property and save on energy bills.

### TRIPLE GLAZING

The Signature Collection casement windows are available with 28mm double or 40mm triple glazing – capable of achieving a U-value of 0.8 with EnergyPlus profile whilst reducing noise.

### BEAUTIFUL COLOURS

Not just available in standard white, The Signature Collection casement windows are available in a huge choice of colours – and with many colours available from stock, you won't have to wait months for your new windows. Ask for a The Signature Collection colour swatch booklet to see samples of our high quality coloured foils that gives you the choice you deserve.

### CHOICE FOR HOMEOWNERS

With a range of optional extras including Mock Sash Horns, Georgian and Astrical Bars, together with a wide range of colour options, you will be spoilt for choice.

### STRONG AND SECURE

Available upgrades mean that The Signature Collection casement window frames can hold Secured by Design status. A police-backed initiative, Secured by Design is awarded to products designed with exceptional security features as their main priority. Products that hold this certification are tested to meet the requirements of the Association of Chief Police Officers.

### LOW MAINTENANCE

The Signature Collection casement windows will never rot, rust, or require painting – just a quick clean with warm soapy water, even with our foiled colours.

## COLOURS

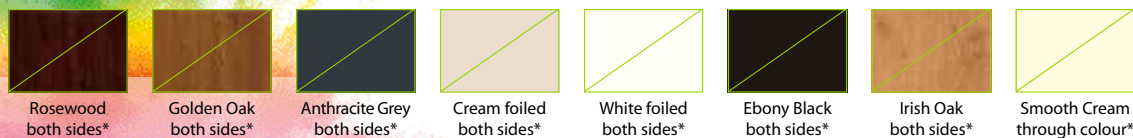

## Bespoke Colour Options



Colours marked \* are from our standard collection in featured profile, all other colours are subject to price and availability on application. Please note: colours are for illustration purposes, for an exact example please ask your sales representative for a Renolit swatch sample. Choose from a wide variety of colour options including: White, Rosewood, Cream, Light Oak, Chartwell Green, Grey and classic Ebony Black. The Signature Collection products are also offered in a wide choice of bespoke colours, please see Renolit foil book, (subject to availability and price on application only). Please note: Ebony Black both sides patios and bi-folds are subject to lead time.

- **10 Years Mechanical Warranty on:**
  - Friction Stays
  - Window Handles
  - Sentinel Easy Fit Locking Mechanisms
- **10 Years Profile Warranty**
- **Available from an entry level "C" Rated to an "A++" Energy rating**
- **Achievable "U-values as low as 0.8"**
- **Secured by Design upgrade available on request**
- **40mm glazing option**
- **Range of hinges easy clean / fire escape / restrictor**
- **Full colour range**
- **Minimum size square 350mm w x 350mm h**
- **Maximum size side opening sash 700mm w x 1300mm h**
- **Maximum size top opening sash 1300mm w x 1300mm h**
- **Unique warranty registration available on request**
- **Slim sight lines (less frame more glass)**
- **8mm sash coverage (best rating for air leakage)**
- **Unique patented double action gasket (30% better compression)**
- **Centralised Euro groove (improved strength and security)**
- **Square cut and scribed beading (ease of glazing)**
- **Single J leg security beads (ease of glazing)**
- **Anti static profile (easy to clean)**
- **32mm Channel packers factory fitted, resulting in huge efficiencies on site glazing, toe and healing packers fitted in position ensuring safe and quicker glazing**
- **All frames are designed to be coupled in many configuration including patio configurations to casement windows**
- **Multiple add on's 10, 20 and 50mm allowing you the perfect choice for every installation**
- **Our system has been designed with the future in mind, uniquely negating the need for the traditional steel reinforcing systems, the benefits being an industry leader in energy efficiencies together with a safer future for the environment, a lead free system with unique PVC inserts that have the same tensile strength of reinforcing**

**10 YEARS**  
**GUARANTEED MECHANICAL WARRANTY**

**Casement Windows**

**10 Years Mechanical Warranty on:**

- Friction Stays
- Window Handles
- Sentinel Easy Fit Locking Mechanisms

**WINDOWS**

All warranties are subject to approval and in conjunction with Pearl Window Systems terms and conditions of sale.

# Flush Sash Windows

## Why choose... The Signature Collection Flush Sash Windows?

Now available in two options for 2019 our current 70mm casement flush sash window is now complimented by the all new Resurgence double-rebated 80mm Flush sash window system, the double-rebated weather seal and patented co-extruded bubble gasket ensure a draught-free, weatherproof window.

Designed to match the rest of the Signature range, Resurgence features fully foiled glazing areas to both outer frame and transom profiles, adding authenticity even when the windows are open. This is the latest exciting development from The Signature Collection, both systems offer the realism of a traditional pre-1932 timber window combined with 21st century thermal benefits whilst enhancing the appearance of any modern day home

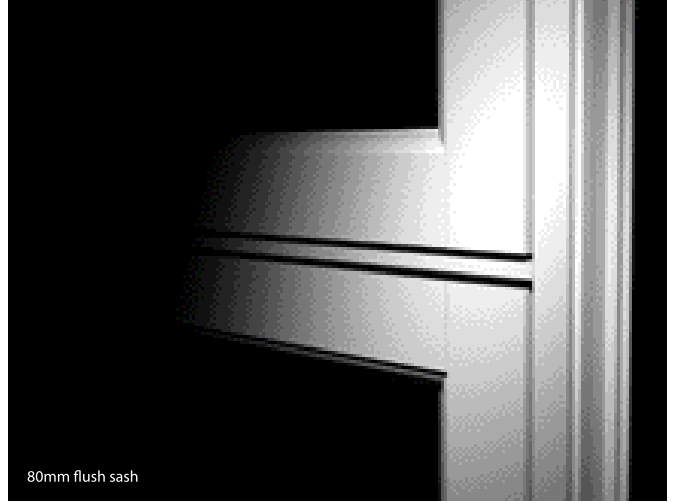

80mm flush sash

### LOOKS LIKE TRADITIONAL TIMBER

Many property owners require a traditional timber window frame, owing to planning or environmental restrictions. Timber frames can be expensive, need regular maintenance and are difficult to replace. The Signature Collection recognised the need to develop a casement window frame that would fit into any property where the sash fitted flush into the frame – and which could be foiled to look like traditional timber or to offer a sleek, contemporary finish giving the aesthetics of wood with the benefits of safe, secure, efficient and great looking windows and doors.

### A+ RATED WINDOWS

The Signature Collection flush sash windows, can be upgraded like the rest of the The Signature Collection EnergyPlus window range, to A+ rated. They offer a lower cost window with higher thermal benefits than timber. Available in sculptured profile with the flush finish on external faces, in 28mm double glazed, internally beaded, with a wide choice of colours, finishes and hardware.



70mm flush sash

### COLOURS

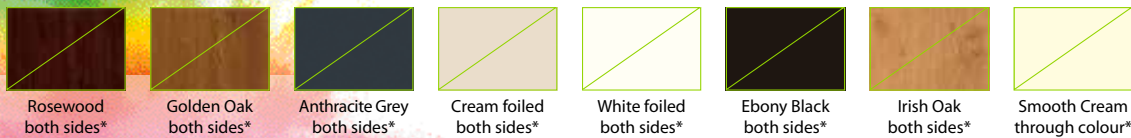

### Bespoke Colour Options

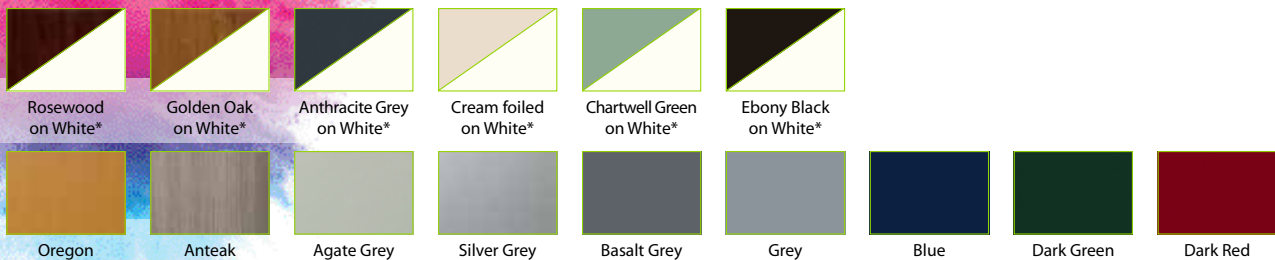

Colours marked \* are from our standard collection in featured profile, all other colours are subject to price and availability on application. Please note: colours are for illustration purposes, for an exact example please ask your sales representative for a Renolit swatch sample. Choose from a wide variety of colour options including: White, Rosewood, Cream, Light Oak, Chartwell Green, Grey and classic Ebony Black. The Signature Collection products are also offered in a wide choice of bespoke colours, please see Renolit foil book, (subject to availability and price on application only). Please note: Ebony Black both sides patios and bi-folds are subject to lead time.

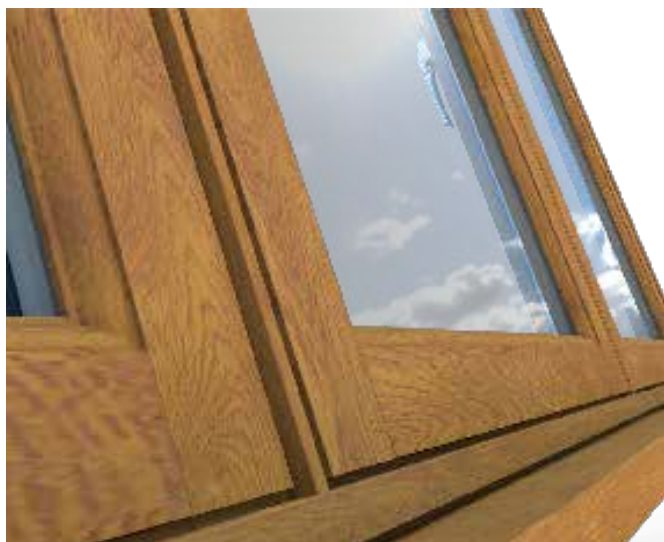

- **10 Years Mechanical Warranty on:**
  - Friction Stays
  - Window Handles
  - Sentinel Easy Fit Locking Mechanisms
- 10 Years Profile Warranty
- Available from an entry level "C" Rated to an "A+" Energy rating
- Range of hinges easy clean / fire escape / restrictor
- Full colour range
- Minimum size square 350mm w x 350mm h
- Maximum size side opening sash 700mm w x 1300mm h
- Maximum size top opening sash 1300mm w x 1300mm h
- Design configurations are limited to two apertures wide or two apertures high, designs outside these configurations are recommended to be split and coupled using the appropriate jointing method recommended by The Signature Collection
- Unique warranty registration available on request
- Slim sight lines (less frame more glass)
- 8mm sash coverage (best rating for air leakage)
- Unique patented double action gasket (30% better compression)
- Centralised Euro groove (improved strength and security)
- Single J leg security beads (ease of glazing)

All warranties are subject to approval and in conjunction with Pearl Window Systems terms and conditions of sale.

- Anti static profile (easy to clean)
- 32mm Channel packers factory fitted, resulting in huge efficiencies on site glazing, toe and healing packers fitted in position ensuring safe and quicker glazing
- All frames are designed to be coupled in many configuration including patio configurations to casement windows
- Multiple add on's 10, 20 and 50mm allowing you the perfect choice for every installation
- Our system has been designed with the future in mind, uniquely negating the need for the traditional steel reinforcing systems, the benefits being an industry leader in energy efficiencies together with a safer future for the environment, a lead free system with unique PVC inserts that have the same tensile strength of reinforcing

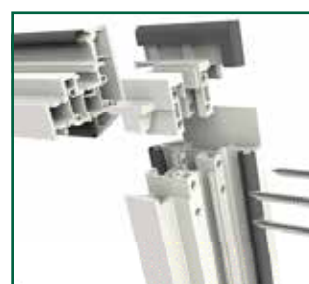

## Casement Windows

**10 Years Mechanical Warranty on:**

- Friction Stays
- Window Handles
- Sentinel Easy Fit Locking Mechanisms

**WINDOWS**

# Bi-Fold Windows



## Why choose... *The Signature Collection* Bi-Fold Windows?

With the ability to enhance almost any type of building, whether modern, contemporary or traditional, The Signature Collection bi-fold windows enable you to fully open one side of a room while retaining valuable wall space for furniture inside.

### VERSATILE

A practical and great looking window solution. The Signature Collection bi-fold windows are popular for use in conservatories and orangeries and are also ideal for the commercial sector. During the summer months they can transform a café or restaurant helping to attract additional customers and give an establishment an outdoor, open feel, while also being secure and child-friendly.

### AT A GLANCE

- Standard four chamber frames.
- Sculptured (curved) styling.
- 28mm double glazed units.
- Add Georgian Bars and/or patterned glass.
- Wide choice of coloured and foiled frames.
- Wide choice of handles and hinge options.



### COLOURS

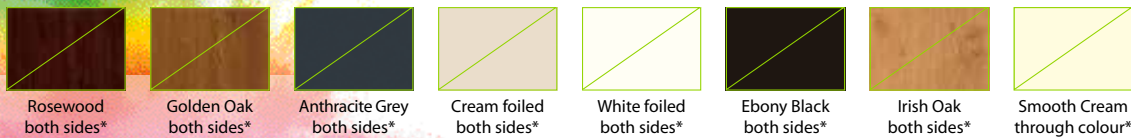

### Bespoke Colour Options



Colours marked \* are from our standard collection in featured profile, all other colours are subject to price and availability on application. Please note: colours are for illustration purposes, for an exact example please ask your sales representative for a Renolit swatch sample. Choose from a wide variety of colour options including: White, Rosewood, Cream, Light Oak, Chartwell Green, Grey and classic Ebony Black. The Signature Collection products are also offered in a wide choice of bespoke colours, please see Renolit foil book, (subject to availability and price on application only). Please note: Ebony Black both sides patios and bi-folds are subject to lead time.



- 10 Years Profile Warranty
- Available from an entry level "C" Rated to an "A+" Energy rating
- Your Bi-Fold Plus benefits from being fitted with the most robust locking mechanisms on the market
- Smooth easy action
- Full colour range
- Hook locking with shootbolts
- Secured by Design option
- Minimum size 600mm w x 1850mm h (sash opening sizes)
- Maximum size 900mm w x 2150mm h (sash opening sizes)
- Slim sight lines (less frame more glass)
- 8mm sash coverage (best rating for air leakage)
- Unique patented double action gasket (30% better compression)
- Centralised Euro groove (improved strength and security)
- Square cut and scribed beading (ease of glazing)
- Single J leg security beads (ease of glazing)
- Anti static profile (easy to clean)
- 32mm Channel packers factory fitted, resulting in huge efficiencies on site glazing, toe and healing packers fitted in position ensuring safe and quicker glazing
- All frames are designed to be coupled in many configuration including patio configurations to casement windows
- Multiple add on's 10, 20 and 50mm allowing you the perfect choice for every installation
- Our system has been designed with the future in mind, uniquely negating the need for the traditional steel reinforcing systems, the benefits being an industry leader in energy efficiencies together with a safer future for the environment, a lead free system with unique PVC inserts that have the same tensile strength of reinforcing

## CONFIGURATIONS

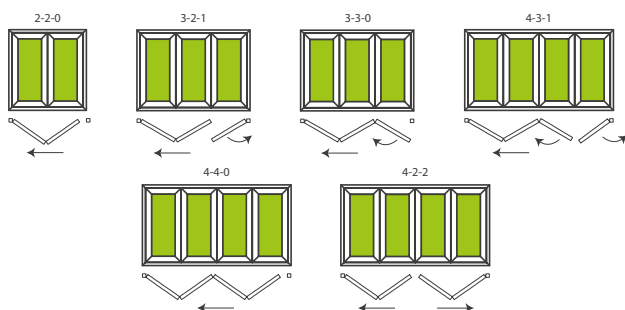

All warranties are subject to approval and in conjunction with Pearl Window Systems terms and conditions of sale.

# Tilt and Turn Windows

## Why choose... *The Signature Collection* Tilt and Turn Windows?



The Signature Collection tilt and turn windows are available in the same ranges as our other window choices – standard or EnergyPlus offering reduced energy bills.

### DESIGN

European design led, the The Signature Collection tilt and turn window allows you to let in fresh air while also offering security giving homeowners a fresher environment whilst maintaining safety in your home.

The open in style gives great options for cleaning from within (in the turn position) and secure ventilation (in the tilt position).

### THERMAL PERFORMANCE

Offering a greater scope for larger openings than a traditional casement window, The Signature Collection's tilt and turn windows are ideal for high-rise as well as low-rise applications, and thermal performance is helped by the larger panes of glass ensuring the lowest possible energy bills.

Perfect as a fire escape giving homeowners piece of mind or simply to let in more fresh air, The Signature Collection tilt and turn windows are available in both 'tilt before turn' or 'turn before tilt' options.

As with all The Signature Collection windows, our tilt and turn windows can be fitted with standard locking, or high security fittings to meet the latest and highest security standards together with a full colour range available.

### COLOURS

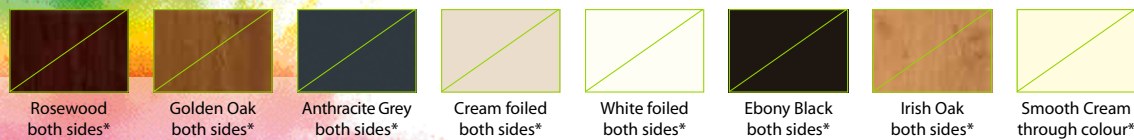

### Bespoke Colour Options

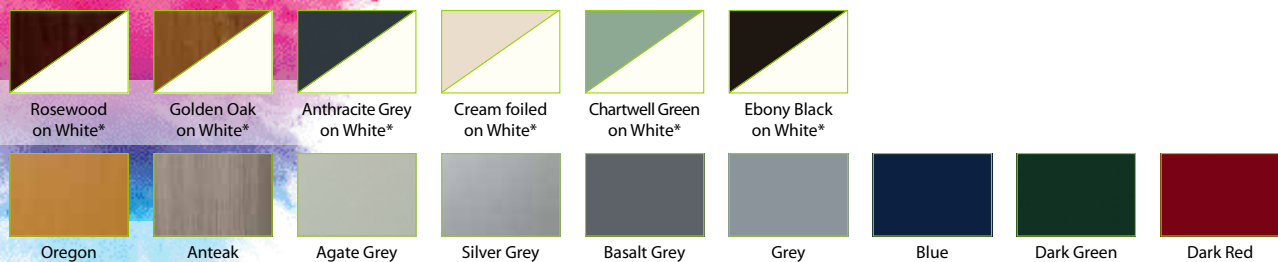

Colours marked \* are from our standard collection in featured profile, all other colours are subject to price and availability on application. Please note: colours are for illustration purposes, for an exact example please ask your sales representative for a Renolit swatch sample. Choose from a wide variety of colour options including: White, Rosewood, Cream, Light Oak, Chartwell Green, Grey and classic Ebony Black. The Signature Collection products are also offered in a wide choice of bespoke colours, please see Renolit foil book, (subject to availability and price on application only). Please note: Ebony Black both sides patios and bi-folds are subject to lead time.

- **10 Years Mechanical Warranty on:**
  - Tilt and Turn Mechanisms
  - Tilt and Turn Hinges
  - Tilt and Turn Handles
- **10 Years Profile Warranty**
- **Available from an entry level “C” rated to an “A+” Energy rating**
- **Beautiful opening configurations available**
- **Full Colour range available**
- **Minimum size 550mm w x 620mm h (sash opening sizes)**
- **Maximum size 1500mm w x 1500mm h (sash opening sizes)**
- **Slim sight lines (less frame more glass)**
- **8mm sash coverage (best rating for air leakage)**
- **Unique patented double action gasket (30% better compression)**
- **Centralised Euro groove (improved strength and security)**
- **Square cut and scribed beading (ease of glazing)**
- **Single J leg security beads (ease of glazing)**
- **Anti static profile (easy to clean)**
- **32mm Channel packers factory fitted, resulting in huge efficiencies on site glazing, toe and healing packers fitted in position ensuring safe and quicker glazing**
- **All frames are designed to be coupled in many configuration including patio configurations to casement windows**
- **Multiple add on’s 10, 20 and 50mm allowing you the perfect choice for every installation**
- **Our system has been designed with the future in mind, uniquely negating the need for the traditional steel reinforcing systems, the benefits being an industry leader in energy efficiencies together with a safer future for the environment, a lead free system with unique PVC inserts that have the same tensile strength of reinforcing**

**10 YEARS**

**GUARANTEED MECHANICAL WARRANTY**

**Tilt and Turn Windows**

**10 Years Mechanical Warranty on:**

- Tilt and Turn Mechanisms
- Tilt and Turn Hinges
- Tilt and Turn Handles

**WINDOWS**

All warranties are subject to approval and in conjunction with Pearl Window Systems terms and conditions of sale.

# French Windows

## Why choose... *The Signature Collection* French Windows?



The Signature Collection French windows are available in our standard or EnergyPlus range, offering a distinctive style of window to shape the look of a home, combined with the practical function of being able to be used as a fire escape, providing both lower energy usage and security to homeowners.

### BESPOKE OPENINGS TAILORED TO SUIT EVERY HOME

Including high security locking, The Signature Collection French windows are available in a wide range of colour choices and offer slim sightlines to let in maximum light giving homeowners a fresher environment.

When you choose The Signature Collection uPVC French windows you can forget worrying about draughts – The Signature Collection’s exclusive double-action bubble gasket, used in all its glazed products, keeps your windows leak-free and weather proof by delivering a continuous seal – even in the corners.



### COLOURS

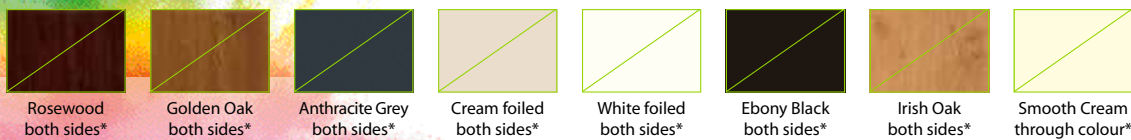

### Bespoke Colour Options



Colours marked \* are from our standard collection in featured profile, all other colours are subject to price and availability on application. Please note: colours are for illustration purposes, for an exact example please ask your sales representative for a Renolit swatch sample. Choose from a wide variety of colour options including: White, Rosewood, Cream, Light Oak, Chartwell Green, Grey and classic Ebony Black. The Signature Collection products are also offered in a wide choice of bespoke colours, please see Renolit foil book, (subject to availability and price on application only). Please note: Ebony Black both sides patios and bi-folds are subject to lead time.

- **10 Years Mechanical Warranty on:**
  - Friction Stays
  - Window Handles
  - Sentinel Easy Fit Locking Mechanisms
- **10 Years Profile Warranty**
- **Available from an entry level "C" Rated to an "A++" Energy rating**
- **Achievable "U-values as low as 0.8"**
- **Secured by Design upgrade available on request**
- **40mm glazing option**
- **Range of hinges easy clean / fire escape / restrictor**
- **Full colour range**
- **Minimum size square 350mm w x 350mm h**
- **Maximum size side opening sash 700mm w x 1300mm h**
- **Maximum size top opening sash 1300mm w x 1300mm h**
- **Unique warranty registration available on request**
- **Slim sight lines (less frame more glass)**
- **8mm sash coverage (best rating for air leakage)**
- **Unique patented double action gasket (30% better compression)**
- **Centralised Euro groove (improved strength and security)**
- **Square cut and scribed beading (ease of glazing)**
- **Single J leg security beads (ease of glazing)**
- **Anti static profile (easy to clean)**
- **32mm Channel packers factory fitted, resulting in huge efficiencies on site glazing, toe and healing packers fitted in position ensuring safe and quicker glazing**
- **All frames are designed to be coupled in many configuration including patio configurations to casement windows**
- **Multiple add on's 10, 20 and 50mm allowing you the perfect choice for every installation**
- **Our system has been designed with the future in mind, uniquely negating the need for the traditional steel reinforcing systems, the benefits being an industry leader in energy efficiencies together with a safer future for the environment, a lead free system with unique PVC inserts that have the same tensile strength of reinforcing**

**10 YEARS**  
**GUARANTEED MECHANICAL WARRANTY**

**Casement Windows**

**10 Years Mechanical Warranty on:**

- Friction Stays
- Window Handles
- Sentinel Easy Fit Locking Mechanisms

**WINDOWS**

All warranties are subject to approval and in conjunction with Pearl Window Systems terms and conditions of sale.

# Bow and Bay Windows



## Why choose... *The Signature Collection* Bow and Bay Windows?

Bow and bay windows are a great way to bring more light into your home. Choose from different designs and colours to add value and style to your home.

### STILL TRADITIONAL

The Signature Collection's innovative bow and bay windows offer a number of features and benefits rarely seen in today's market place. Choose from different styles and colours to find a style to suit you perfectly.

The ultra-slim frames of The Signature Collection's beautiful bow and bay windows increase the flow of natural light as well as creating an enhanced field of view giving a brighter outlook and fresher feel inside the home.

### ADDITIONAL DESIGNS

Enrich the look of your bow and bay windows with a range of additional designs including leaded glass, Georgian or astrical bars, or decorative sash horns to match existing features in your home.

### AT A GLANCE

- With a standard four chamber or unique six chamber PVCu profile, EnergyPlus can easily achieve an A+ rating, helping you to contain and conserve heat within your property reducing energy bills.
- Sculptured (curved) or Chamfered (bevelled).
- 28mm double glazed or 40mm triple glazed units.
- Flush sash style available.

### COLOURS

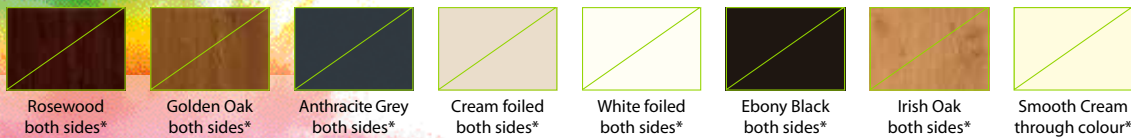

### Bespoke Colour Options

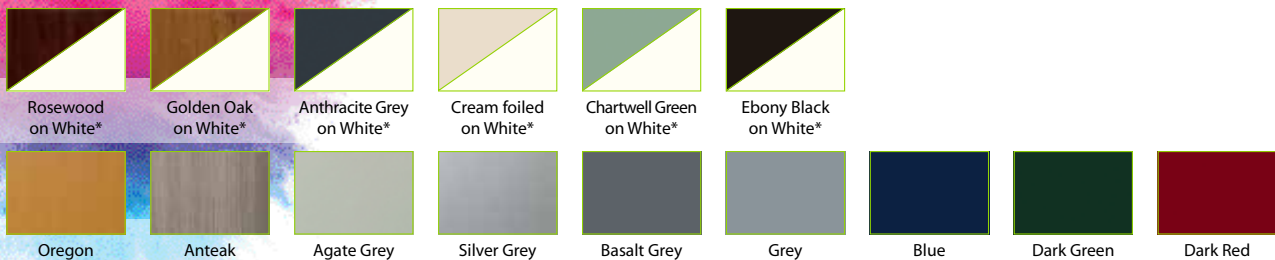

Colours marked \* are from our standard collection in featured profile, all other colours are subject to price and availability on application. Please note: colours are for illustration purposes, for an exact example please ask your sales representative for a Renolit swatch sample. Choose from a wide variety of colour options including: White, Rosewood, Cream, Light Oak, Chartwell Green, Grey and classic Ebony Black. The Signature Collection products are also offered in a wide choice of bespoke colours, please see Renolit foil book, (subject to availability and price on application only). Please note: Ebony Black both sides patios and bi-folds are subject to lead time.

- **10 Years Mechanical Warranty on:**
  - Friction Stays
  - Window Handles
  - Sentinel Easy Fit Locking Mechanisms
- **10 Years Profile Warranty**
- **Available from an entry level "C" Rated to an "A++" Energy rating**
- **Achievable "U-values as low as 0.8"**
- **Secured by Design upgrade available on request**
- **40mm glazing option**
- **Range of hinges easy clean / fire escape / restrictor**
- **Full colour range**
- **Minimum size square 350mm w x 350mm h**
- **Maximum size side opening sash 700mm w x 1300mm h**
- **Maximum size top opening sash 1300mm w x 1300mm h**
- **Unique warranty registration available on request**
- **Slim sight lines (less frame more glass)**
- **8mm sash coverage (best rating for air leakage)**
- **Unique patented double action gasket (30% better compression)**
- **Centralised Euro groove (improved strength and security)**
- **Square cut and scribed beading (ease of glazing)**
- **Single J leg security beads (ease of glazing)**
- **Anti static profile (easy to clean)**
- **32mm Channel packers factory fitted, resulting in huge efficiencies on site glazing, toe and healing packers fitted in position ensuring safe and quicker glazing**
- **All frames are designed to be coupled in many configuration including patio configurations to casement windows**
- **Multiple add on's 10, 20 and 50mm allowing you the perfect choice for every installation**
- **Our system has been designed with the future in mind, uniquely negating the need for the traditional steel reinforcing systems, the benefits being an industry leader in energy efficiencies together with a safer future for the environment, a lead free system with unique PVC inserts that have the same tensile strength of reinforcing**



**10 YEARS**  
**GUARANTEED MECHANICAL WARRANTY**

**Casement Windows**

**10 Years Mechanical Warranty on:**

- Friction Stays
- Window Handles
- Sentinel Easy Fit Locking Mechanisms

**WINDOWS**

All warranties are subject to approval and in conjunction with Pearl Window Systems terms and conditions of sale.

# French Doors



## Why choose... *The Signature Collection* French Doors?

An attractive alternative to patio or bi-folding doors, The Signature Collection's range of French doors are an ideal choice where the aperture size is more limiting and where the homeowner demands quality, style and security.

### KEEPING IN ITS TRADITION

Offering a more traditional aesthetic, The Signature Collection's stunning range of uPVC French doors come with the same high specification and colour choices as our window range offering homeowners a wider choice. Available in either an 'open in' or 'open out' style to suit your living space, the The Signature Collection French door provides your home with a beautiful and secure entrance – along with a range of patented low and ultra-low threshold options including ramp thresholds for disabled access.

### BEAUTIFUL FINISH

Ensuring you enjoy the maximum amount of natural light in your home, the fully sculptured features of the The Signature Collection French door provides a beautiful finish. The Signature Collection French doors are not only lead-free and aesthetically pleasing but have been created with security giving homeowners piece of mind.

### STRONG AND SECURE

Whilst all our doors are manufactured using the latest security products, available upgrades mean that all The Signature Collection products can be upgraded to meet the necessary standards, including Secured by Design and PAS24:2016, plus they are fully compliant with the latest relevant divisions of the Building Regulations.

### VARIETY OF CHOICES

Available in chamfered or sculptured profile, 28mm double or 40mm triple glazing, with standard four chamber or EnergyPlus six chamber profile – along with threshold choices (including Part M compliant) and a great range of hardware, finishes and glazing options. Choose from a wide variety of colour options including White, Rosewood, Cream, Irish Oak, and Light Oak. The Signature Collection French doors are also offered in a choice of bespoke colours including Chartwell Green, Grey and classic Black designed to suit any home.

### COLOURS

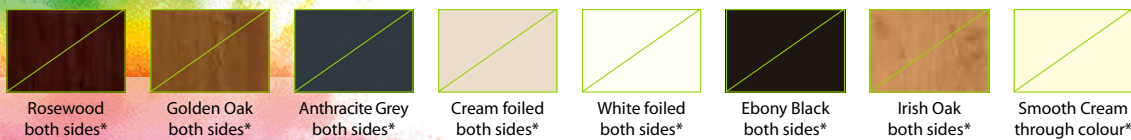

### Bespoke Colour Options

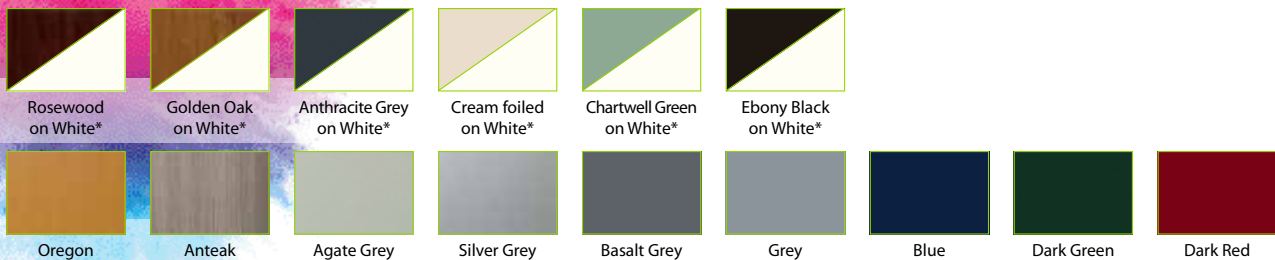

Colours marked \* are from our standard collection in featured profile, all other colours are subject to price and availability on application. Please note: colours are for illustration purposes, for an exact example please ask your sales representative for a Renolit swatch sample. Choose from a wide variety of colour options including: White, Rosewood, Cream, Light Oak, Chartwell Green, Grey and classic Ebony Black. The Signature Collection products are also offered in a wide choice of bespoke colours, please see Renolit foil book, (subject to availability and price on application only). Please note: Ebony Black both sides patios and bi-folds are subject to lead time.



- **10 Years Mechanical Warranty on:**
  - Door Locks
  - Cylinders
  - Door Handles
  - Pro Secure Door Hinges
- **Lifetime Coating Warranty on:**
  - Marine Grade Stainless Steel Gold and Chrome Door Handles
  - Marine Grade Stainless Steel Gold and Chrome Letter Plates
- **10 Years Profile Warranty**
- **Available from an entry level "C" Rated to an "A+" Energy rating**
- **Shootbolt locking**
- **Double handles**
- **Secured by Design upgrade available on request**
- **40mm glazing option**
- **Full colour range**
- **Maximum size 1000mm w x 2150mm h (sash size)**
- **Unique warranty registration available on request**
- **77mm Door suite creating 22mm from edge of hinge to outer-frame which in many cases reduces the need for add on to your door, better sight lines and more cost effective**
- **Available on request colour coordinated door flag hinges, aesthetically pleasing to compliment your choice of coloured doors**
- **Slim sight lines (less frame more glass)**
- **8mm sash coverage (best rating for air leakage)**
- **Unique patented double action gasket (30% better compression)**
- **Centralised Euro groove (improved strength and security)**
- **Square cut and scribed beading (ease of glazing)**

- **Single J leg security beads (ease of glazing)**
- **Anti static profile (easy to clean)**
- **32mm Channel packers factory fitted, resulting in huge efficiencies on site glazing, toe and healing packers fitted in position ensuring safe and quicker glazing**
- **All frames are designed to be coupled in many configuration including patio configurations to casement windows**
- **Multiple add on's 10, 20 and 50mm allowing you the perfect choice for every installation**
- **Our system has been designed with the future in mind, uniquely negating the need for the traditional steel reinforcing systems, the benefits being an industry leader in energy efficiencies together with a safer future for the environment, a lead free system with unique PVC inserts that have the same tensile strength of reinforcing**



**10 Years Mechanical Warranty**

**Single and French Residential Doors**

**10 Years Mechanical Warranty on:**

- Door Locks
- Cylinders
- Door Handles
- Pro Secure Door Hinges



**Lifetime Coating Warranty**

**Single and French Residential Doors**

**Lifetime Coating Warranty on:**

- Marine Grade Stainless Steel Gold and Chrome Door Handles
- Marine Grade Stainless Steel Gold and Chrome Letter Plates

**DOORS**

All warranties are subject to approval and in conjunction with Pearl Window Systems terms and conditions of sale.

# Composite Doors



## Why choose... *The Signature Collection* Composite Doors?

Your front door is the face of your property. It's the first thing you see when you arrive home in the evening, the last thing you see when you leave in the morning and the sight that welcomes your visitors setting their first impression.

### PERFECT COMBINATION

Composite Doors are made from a variety of materials, including uPVC, wood, insulating foam and glass reinforced plastic (GRP). This combination of materials results in a very strong and secure door. The Signature Collection composite doors have a high resistance to weathering and don't react to seasonal changes like a singular material door would. The insulation foam core provides a higher thermal resistance than timber doors. The Signature Collection composite doors are designed with an attractive woodgrain appearance but, because of the materials used, they won't fade or discolour – and neither will they need painting, and don't warp in damp conditions.

### STRONG AND SECURE

Whether your home is a rural retreat or on a busy main road, a The Signature Collection composite door guarantees low maintenance with secure and enduring performance. If you are seeking to replace an existing door or add some character to your property, The Signature Collection is sure to have a solution. The Signature Collection composite doors are not only aesthetically pleasing and lead-free but have been designed with security in mind.

### WIDE CHOICE OF COLOURS

Composite doors are available in a wide range of colour options to give your home a stunning appearance. Colour options for both the door and the frame include White, Cream, Rosewood, Light Oak, and Irish Oak, as well as Grey, Black and Chartwell Green.

### COLOURS

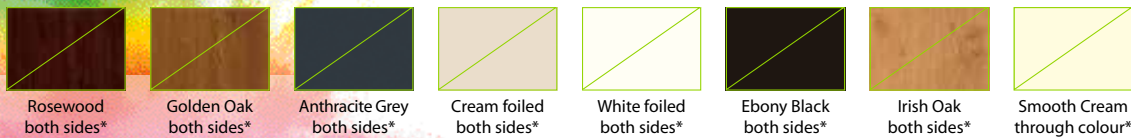

### Bespoke Colour Options

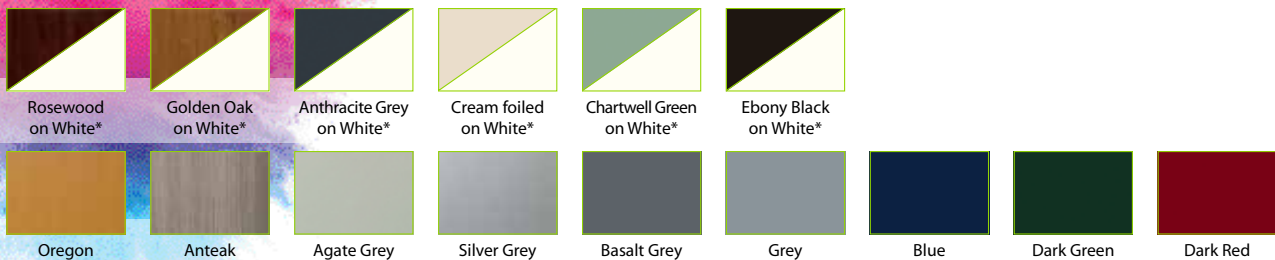

Colours marked \* are from our standard collection in featured profile, all other colours are subject to price and availability on application. Please note: colours are for illustration purposes, for an exact example please ask your sales representative for a Renolit swatch sample. Choose from a wide variety of colour options including: White, Rosewood, Cream, Light Oak, Chartwell Green, Grey and classic Ebony Black. The Signature Collection products are also offered in a wide choice of bespoke colours, please see Renolit foil book, (subject to availability and price on application only). Please note: Ebony Black both sides patios and bi-folds are subject to lead time.



- **10 Years Mechanical Warranty on:**
  - Door Locks
  - Cylinders
  - Door Handles
  - Composite Door Hinges
- **Lifetime Coating Warranty on:**
  - Marine Grade Stainless Steel Gold and Chrome Door Handles
  - Marine Grade Stainless Steel Gold and Chrome Letter Plates
- **10 Years Profile Warranty**
- **Available from an entry level "C" Rated to an "A+" Energy rating**
- **Secured by Design upgrade available on request**
- **Full colour range**
- **Maximum size 1000mm x 2100mm (overall size subject to design)**

All warranties are subject to approval and in conjunction with Pearl Window Systems terms and conditions of sale.



**Composite Doors**

**10 Years Mechanical Warranty on:**

- Door Locks
- Cylinders
- Door Handles
- Composite Door Hinges



**Composite Doors**

**Lifetime Coating Warranty on:**

- Marine Grade Stainless Steel Gold and Chrome Door Handles
- Marine Grade Stainless Steel Gold and Chrome Letter Plates



## Why choose... *The Signature Collection* Residential Doors?

A front door is the face of your home. It's the last thing you see when you're locking up and the first thing you see when you arrive home. It's the first impression that meets any callers to your home. With a The Signature Collection door you can ensure it's the best you can present.

### FIRST IMPRESSIONS

Whether you are looking to add some character to your home, or are looking for some traditional style, The Signature Collection is sure to have the perfect solution.

The Signature Collection's uPVC residential doors are available as opening in or opening out, and are designed to match perfectly with the window range to create a co-ordinated and attractive appearance for your home.

With matching sidelights to let in more light, decorative glazing options, handles, letterboxes and knockers, you can personalise your front door to your exact preferences adding the personal touch to your home.

The Signature Collection residential doors provide both a great aesthetic and are lead-free, and have also been designed to offer excellent levels of security.

### FULLY ACCREDITED

Security is a vital component of all The Signature Collection products and our doors are fully accredited to meet the appropriate standards, including upgrades to PAS24:2016 and Secured by Design, and are also fully compliant with the latest relevant sections of the Building Regulations.

### AT A GLANCE

There are many options available to ensure the perfect door for each unique customer. Choose from chamfered or sculptured profile, double glazing (28mm) or triple glazing (40mm), with standard four chamber or EnergyPlus six chamber profile. Combine this with a choice of threshold options, disabled ramp thresholds, Part M building compliant or just a simple low PVC threshold, not forgetting the wide range of finishes together with stunning hardware options.

### COLOURS

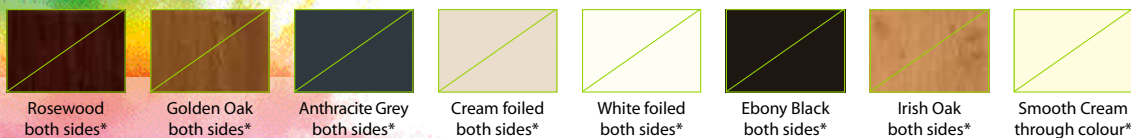

### Bespoke Colour Options

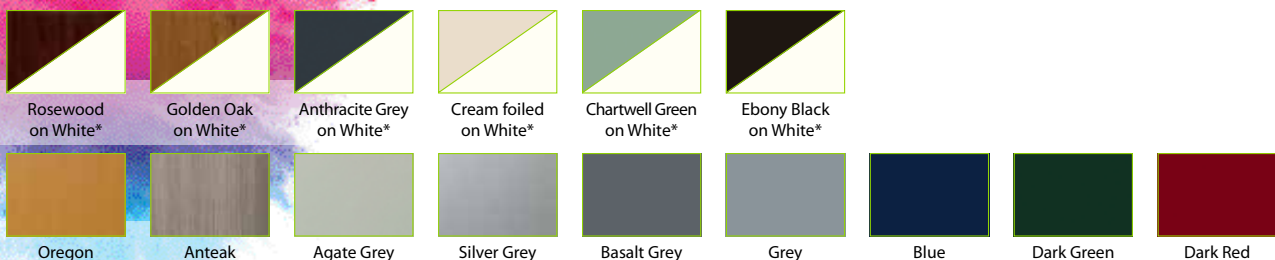

Colours marked \* are from our standard collection in featured profile, all other colours are subject to price and availability on application. Please note: colours are for illustration purposes, for an exact example please ask your sales representative for a Renolit swatch sample. Choose from a wide variety of colour options including: White, Rosewood, Cream, Light Oak, Chartwell Green, Grey and classic Ebony Black. The Signature Collection products are also offered in a wide choice of bespoke colours, please see Renolit foil book, (subject to availability and price on application only). Please note: Ebony Black both sides patios and bi-folds are subject to lead time.

- **10 Years Mechanical Warranty on:**
  - Door Locks
  - Cylinders
  - Door Handles
  - Pro Secure Door Hinges
- **Lifetime Coating Warranty on:**
  - Marine Grade Stainless Steel Gold and Chrome Door Handles
  - Marine Grade Stainless Steel Gold and Chrome Letter Plates
- **10 Years Profile Warranty**
- **Available from an entry level "C" Rated to an "A+" Energy rating**
- **Secured by Design upgrade available on request**
- **40mm glazing option**
- **Full colour range**
- **Maximum size 1000mm w x 2150mm h (sash size)**
- **Unique warranty registration available on request**
- **77mm Door suite creating 22mm from edge of hinge to outer-frame which in many cases reduces the need for add on to your door, better sight lines and more cost effective**
- **Available on request colour coordinated door flag hinges, aesthetically pleasing to compliment your choice of coloured doors**
- **Slim sight lines (less frame more glass)**
- **8mm sash coverage (best rating for air leakage)**
- **Unique patented double action gasket (30% better compression)**
- **Centralised Euro groove (improved strength and security)**
- **Square cut and scribed beading (ease of glazing)**
- **Single J leg security beads (ease of glazing)**
- **Anti static profile (easy to clean)**

- **32mm Channel packers factory fitted, resulting in huge efficiencies on site glazing, toe and healing packers fitted in position ensuring safe and quicker glazing**
- **All frames are designed to be coupled in many configuration including patio configurations to casement windows**
- **Multiple add on's 10, 20 and 50mm allowing you the perfect choice for every installation**
- **Our system has been designed with the future in mind, uniquely negating the need for the traditional steel reinforcing systems, the benefits being an industry leader in energy efficiencies together with a safer future for the environment, a lead free system with unique PVC inserts that have the same tensile strength of reinforcing**



**10 Years  
Guaranteed Mechanical  
Warranty**

**Single and French Residential Doors**

**10 Years Mechanical Warranty on:**

- Door Locks
- Cylinders
- Door Handles
- Pro Secure Door Hinges



**Lifetime  
Guaranteed Coating  
Warranty**

**Single and French Residential Doors**

**Lifetime Coating Warranty on:**

- Marine Grade Stainless Steel Gold and Chrome Door Handles
- Marine Grade Stainless Steel Gold and Chrome Letter Plates

**DOORS**

All warranties are subject to approval and in conjunction with Pearl Window Systems terms and conditions of sale.

# Stable Doors

## Why choose... *The Signature Collection* Stable Doors?



For a classic and charming alternative to a standard back door, The Signature Collection residential doors are also available in an elegant stable door style offering an elegant touch to any home.

### A TIMELESS APPEARANCE FOR ANY PROPERTY

This country style is suited to both modern and period properties if you are looking for that traditional touch to enhance your home.

Allowing for quick and easy ventilation, The Signature Collection stable doors offer great versatility, allowing the two halves of the door to be opened independently from one another, providing easy access for small children and pets.

### AT A GLANCE

There are many options available to ensure the perfect door for each unique customer. Choose from chamfered or sculptured profile, double glazing (28mm) or triple glazing (40mm), with standard four chamber or EnergyPlus six chamber profile. Combine this with a choice of threshold options, disabled ramp thresholds, Part M building compliant or just a simple low PVC threshold, not forgetting the wide range of finishes together with stunning hardware options.

### COLOURS

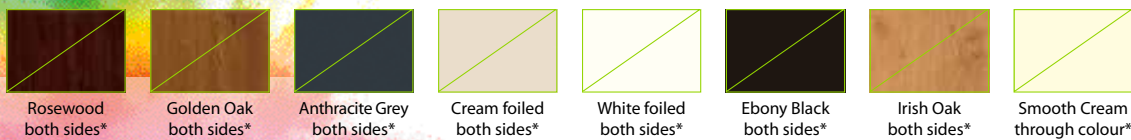

### Bespoke Colour Options

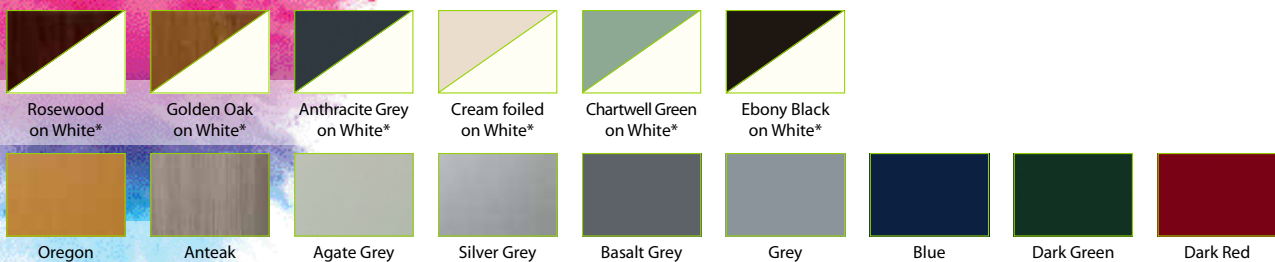

Colours marked \* are from our standard collection in featured profile, all other colours are subject to price and availability on application. Please note: colours are for illustration purposes, for an exact example please ask your sales representative for a Renolit swatch sample. Choose from a wide variety of colour options including: White, Rosewood, Cream, Light Oak, Chartwell Green, Grey and classic Ebony Black. The Signature Collection products are also offered in a wide choice of bespoke colours, please see Renolit foil book, (subject to availability and price on application only). Please note: Ebony Black both sides patios and bi-folds are subject to lead time.

- **10 Years Mechanical Warranty on:**
  - Door Locks
  - Cylinders
  - Door Handles
  - Composite Door Hinges
- **Lifetime Coating Warranty on:**
  - Marine Grade Stainless Steel Gold and Chrome Door Handles
  - Marine Grade Stainless Steel Gold and Chrome Letter Plates
- **10 Years Profile Warranty**
- **Available from an entry level "C" Rated to an "A+" Energy rating**
- **Secured by Design upgrade available on request**
- **40mm glazing option**
- **Full colour range**
- **Maximum size 1000mm w x 2150mm h (sash size)**
- **Unique warranty registration available on request**
- **77mm Door suite creating 22mm from edge of hinge to outer-frame which in many cases reduces the need for add on to your door, better sight lines and more cost effective**
- **Available on request colour coordinated door flag hinges, aesthetically pleasing to compliment your choice of coloured doors**
- **Slim sight lines (less frame more glass)**
- **8mm sash coverage (best rating for air leakage)**
- **Unique patented double action gasket (30% better compression)**
- **Centralised Euro groove (improved strength and security)**
- **Square cut and scribed beading (ease of glazing)**
- **Single J leg security beads (ease of glazing)**
- **Anti static profile (easy to clean)**

- **32mm Chanel packers factory fitted, resulting in huge efficiencies on site glazing, toe and healing packers fitted in position ensuring safe and quicker glazing**
- **All frames are designed to be coupled in many configuration including patio configurations to casement windows**
- **Multiple add on's 10, 20 and 50mm allowing you the perfect choice for every installation**
- **Our system has been designed with the future in mind, uniquely negating the need for the traditional steel reinforcing systems, the benefits being an industry leader in energy efficiencies together with a safer future for the environment, a lead free system with unique PVC inserts that have the same tensile strength of reinforcing**



**Composite Doors**

**10 Years Mechanical Warranty on:**

- Door Locks
- Cylinders
- Door Handles
- Composite Door Hinges



**Composite Doors**

**Lifetime Coating Warranty on:**

- Marine Grade Stainless Steel Gold and Chrome Door Handles
- Marine Grade Stainless Steel Gold and Chrome Letter Plates

**DOORS**

All warranties are subject to approval and in conjunction with Pearl Window Systems terms and conditions of sale.

# Standard Bi-Fold Doors



## Why choose... *The Signature Collection* Standard Bi-Fold Doors?

The Signature Collection offered the very first fully bespoke uPVC bi-fold doors to be engineered, designed and manufactured in the UK – and The Signature Collection bi-fold doors are still the very best.

### BRINGING THE OUTSIDE IN

Bi-fold doors are the perfect way for you to create space, let in fresh air and flood your home with natural daylight by being able to open up an entire wall of your home. Whatever purpose you have for your bi-fold doors, the The Signature Collection product provides a truly stunning alternative to French or patio doors.

### EXPLAINING ENERGY EFFICIENCY

The installation of energy efficient windows, doors and roofs is one of the best ways you can save energy within your home. Mainly due to our innovative uPVC multi-chambered profile design, The Signature Collection frames outperform most of the other leading brands in the UK. A door's thermal efficiency is measured in U-values. These demonstrate the effectiveness of a door at stopping the movement of heat into and out of a property. The lower the U-value is, the higher the door's efficiency at preserving the heat inside of a building when cold outside, resulting in reduced energy costs.

### INNOVATIVE

Slim hinges have been added, with hidden fixings inside. This not only seamlessly preserves the sleek lines but increases security as it is impossible for them to be unscrewed externally. We designed our own innovative solution to enable us to offer a low threshold without the need for expensive and messy excavation. It's often the little things that make a big difference – we've even designed folding keys to avoid any problems with keys being left in the locks during use.

### ULTRA-SLIM SIGHTLINES

The Signature Collection bi-fold doors have ultra-slim sightlines, providing rooms with a modern, clean appearance – and are available in a wide choice of opening configurations and colours. The innovative low threshold option is just one of the safety features included, making them family and wheelchair friendly. Find out about the range of thresholds available from your sales representative.

### COLOURS

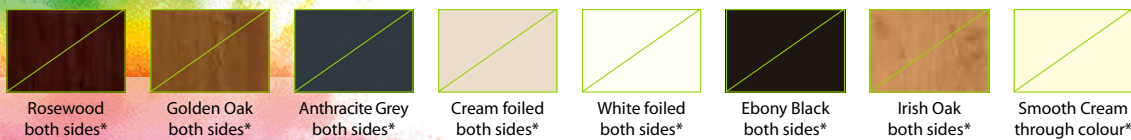

### Bespoke Colour Options

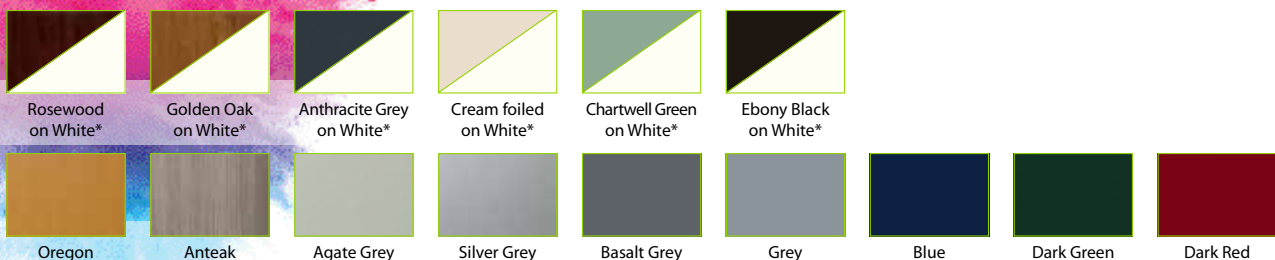

Colours marked \* are from our standard collection in featured profile, all other colours are subject to price and availability on application. Please note: colours are for illustration purposes, for an exact example please ask your sales representative for a Renolit swatch sample. Choose from a wide variety of colour options including: White, Rosewood, Cream, Light Oak, Chartwell Green, Grey and classic Ebony Black. The Signature Collection products are also offered in a wide choice of bespoke colours, please see Renolit foil book, (subject to availability and price on application only). Please note: Ebony Black both sides patios and bi-folds are subject to lead time.



- 10 Years Profile Warranty
- Available from an entry level "C" Rated to an "A+" Energy rating
- Smooth easy action
- Full colour range
- Hook locking with shootbolts
- Secured by Design option
- Minimum size 600mm w x 1850mm h (sash opening sizes)
- Maximum size 800mm w x 2150mm h (sash opening sizes)
- Slim sight lines (less frame more glass)
- 8mm sash coverage (best rating for air leakage)
- Unique patented double action gasket (30% better compression)
- Centralised Euro groove (improved strength and security)
- Single J leg security beads (ease of glazing)
- Anti static profile (easy to clean)
- 32mm Chanel packers factory fitted, resulting in huge efficiencies on site glazing, toe and healing packers fitted in position ensuring safe and quicker glazing
- All frames are designed to be coupled in many configuration including patio configurations to casement windows
- Multiple add on's 10, 20 and 50mm allowing you the perfect choice for every installation
- Our system has been designed with the future in mind, uniquely negating the need for the traditional steel reinforcing systems, the benefits being an industry leader in energy efficiencies together with a safer future for the environment, a lead free system with unique PVC inserts that have the same tensile strength of reinforcing

## STANDARD BI-FOLD CONFIGURATIONS

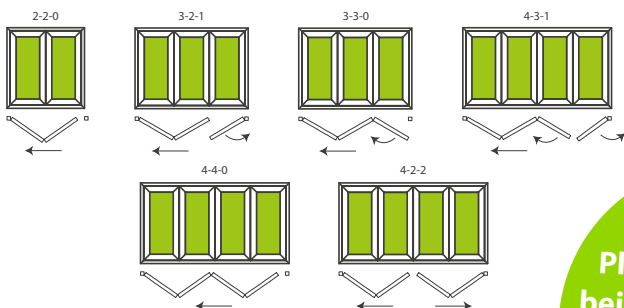

Your Bi-Fold  
Plus benefits from  
being fitted with the  
most robust locking  
mechanisms on the  
market!

All warranties are subject to approval and in conjunction with Pearl Window Systems terms and conditions of sale.

# ModLok™ Bi-Folding Doors



## Why choose... *The Signature Collection* Bi-Folding Doors?

The Signature Collection's ModLok™ bi-folding doors offer a totally unique option, thanks to the patented exoskeleton design giving them unparalleled strength, security and durability giving homeowners piece of mind.

### **TIMELESS IN APPEARANCE AND ROBUST ENOUGH TO IMPRESS A QUEEN**

No other PVCu bi-folding door has been tested to over 127,000 full opening cycles; and with low U-values, PAS:24 and Secured By Design accreditation, the The Signature Collection ModLok™ is in a class of its own – earning the accolade of a Queen's Award for Enterprise in Innovation in 2017. Ideal for large openings, ModLok™ bi-folds enable you to open up an entire wall of your room.

### **SUPERIOR EFFICIENCY**

And The Signature Collection's 'top of the range' ModLok™ bi-fold doors offer even greater strength and rigidity, combining all of the structural benefits of an aluminium door set with the energy efficiency of uPVC, all 'bottom rolling', not top-hung.

### **STUNNING ALTERNATIVE**

Whether you have a bedroom with a Juliette balcony, a kitchen-diner, a conservatory or an orangery, The Signature Collection ModLok™ bi-folding doors can provide a stunning alternative to patio or French doors. Available in a wide choice of opening configurations and colours, the The Signature Collection ModLok™ bi-fold has ultra-slim sightlines, providing rooms with a clean, modern appearance. Safety features include the innovative low threshold option for family friendly and wheelchair use. What's more, The Signature Collection bi-fold doors offer high energy efficiency, combined with the best security features on the market – bringing you a modern space-saving solution for your home that will definitely give it the 'wow' factor. Find out about the range of thresholds available from your sales representative.

### **COLOURS**

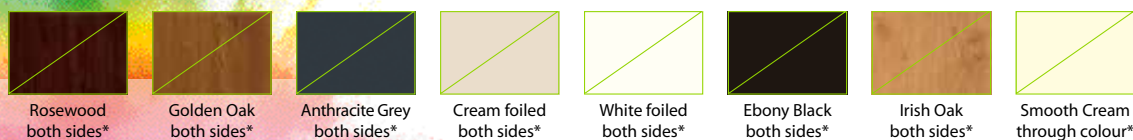

### **Bespoke Colour Options**

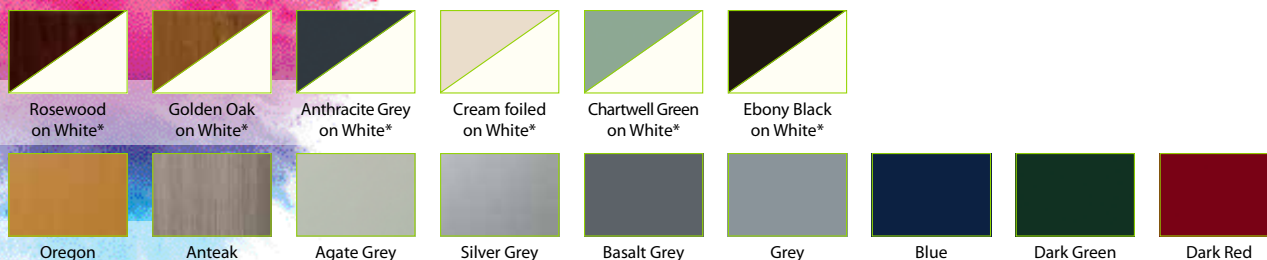

Colours marked \* are from our standard collection in featured profile, all other colours are subject to price and availability on application. Please note: colours are for illustration purposes, for an exact example please ask your sales representative for a Renolit swatch sample. Choose from a wide variety of colour options including: White, Rosewood, Cream, Light Oak, Chartwell Green, Grey and classic Ebony Black. The Signature Collection products are also offered in a wide choice of bespoke colours, please see Renolit foil book, (subject to availability and price on application only). Please note: Ebony Black both sides patios and bi-folds are subject to lead time.

- 10 Years Profile Warranty
- Available from an entry level "C" Rated to an "A+" Energy rating
- Your Bi-Fold Plus benefits from being fitted with the most robust locking mechanisms on the market
- Smooth easy action
- Full colour range
- Hook locking with shootbolts
- Secured by Design Security upgrades available on request
- Minimum size 600mm w x 1850mm h (sash opening sizes)
- Maximum size 1000mm w x 2150mm h (sash opening sizes)
- Slim sight lines (less frame more glass)
- 8mm sash coverage (best rating for air leakage)
- Unique patented double action gasket (30% better compression)
- Centralised Euro groove (improved strength and security)
- Single J leg security beads (ease of glazing)
- Anti static profile (easy to clean)
- 32mm Channel packers factory fitted, resulting in huge efficiencies on site glazing, toe and healing packers fitted in position ensuring safe and quicker glazing
- All frames are designed to be coupled in many configuration including patio configurations to casement windows
- Multiple add on's 10, 20 and 50mm allowing you the perfect choice for every installation
- Our system has been designed with the future in mind, uniquely negating the need for the traditional steel reinforcing systems, the benefits being an industry leader in energy efficiencies together with a safer future for the environment, a lead free system with unique PVC inserts that have the same tensile strength of reinforcing

## MODLOK™ AND ALUMINA CONFIGURATIONS

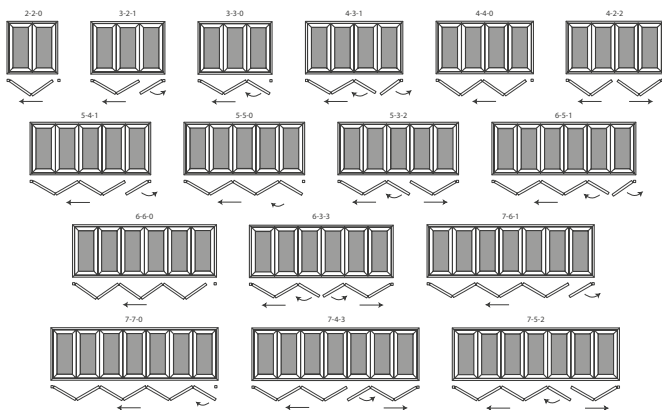

All warranties are subject to approval and in conjunction with Pearl Window Systems terms and conditions of sale.

# ModLok™ Patio Doors



## Why choose... The Signature Collection ModLok™ Patio Doors?

Whether you're looking for a brand new patio door to provide better access to your garden, or you're looking for a replacement door, you'll be amazed at how different the stunning The Signature Collection patio range is from other patio doors on the market.

### SILENT ACTION

The built-in brushes gently sweep away any minor debris each time the door is closed, aiding its silent action and helping it to maintain efficient operation. With fully sculptured features providing a beautiful finish, the The Signature Collection patio door's ultra-slim sightlines ensure you enjoy the maximum amount of natural light in your home. And with a range of colour and handle options, you can personalise your The Signature Collection patio doors to match the rest of your home, because they are designed just for you.

### ENGINEERED FOR THE FUTURE – AVAILABLE TODAY

The sliding patio door isn't a new invention and most doors available on the market today are still based on a historic design, which means they come with inherent challenges.

Who hasn't experienced a patio door that rocks on its track, or one that requires sheer brute force to open? Other patio doors have also built an unwanted reputation for making it easy for thieves to break in to your home. The Signature Collection design team have re-written the rule book with their innovative patio doors range – engineering in features such as a built-in decelerator and hidden 'crash stops' within the operating mechanism so as not to detract from the beautifully slim lines of the door.

### HIGH LEVELS OF SECURITY

In addition the The Signature Collection door is one of the most secure patio doors available today. The Signature Collection's patented ModLok™ modular locking mechanism is built into the frame, delivering unparalleled strength combined with the highest levels of security. ModLok™ Patio Doors give you and your family peace of mind that your home is protected.

### COLOURS

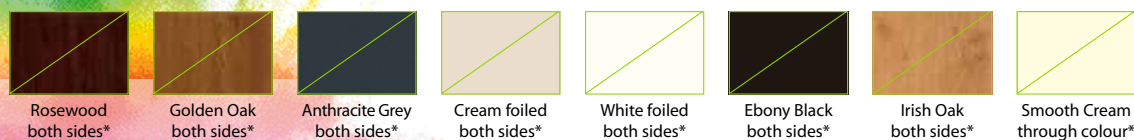

### Bespoke Colour Options

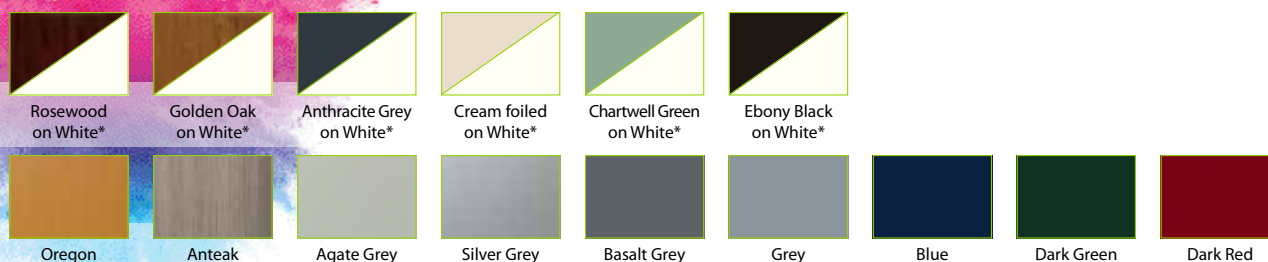

Colours marked \* are from our standard collection in featured profile, all other colours are subject to price and availability on application. Please note: colours are for illustration purposes, for an exact example please ask your sales representative for a Renolit swatch sample. Choose from a wide variety of colour options including: White, Rosewood, Cream, Light Oak, Chartwell Green, Grey and classic Ebony Black. The Signature Collection products are also offered in a wide choice of bespoke colours, please see Renolit foil book, (subject to availability and price on application only). Please note: Ebony Black both sides patios and bi-folds are subject to lead time.

- 10 Years Profile Warranty
- Available from an entry level "C" Rated to an "A+" Energy rating
- Multi-chambered energy rated profiles
- Full colour range
- High security ModLok Hook locks with shootbolts
- Anti-snap Security barrel covered by handle
- Unique air glide wheels
- Minimum size 1600mm w x 1900mm h
- Maximum size 2950mm w x 2400mm h (x2 pane patio)
- Slim sight lines (less frame more glass)
- 8mm sash coverage (best rating for air leakage)
- Unique patented double action gasket (30% better compression)
- Centralised Euro groove (improved strength and security)
- Single J leg security beads (ease of glazing)
- Anti static profile (easy to clean)
- 32mm Channel packers factory fitted, resulting in huge efficiencies on site glazing, toe and healing packers fitted in position ensuring safe and quicker glazing
- All frames are designed to be coupled in many configuration including patio configurations to casement windows
- Multiple add on's 10, 20 and 50mm allowing you the perfect choice for every installation
- Our system has been designed with the future in mind, uniquely negating the need for the traditional steel reinforcing systems, the benefits being an industry leader in energy efficiencies together with a safer future for the environment, a lead free system with unique PVC inserts that have the same tensile strength of reinforcing

## PATIO CONFIGURATIONS

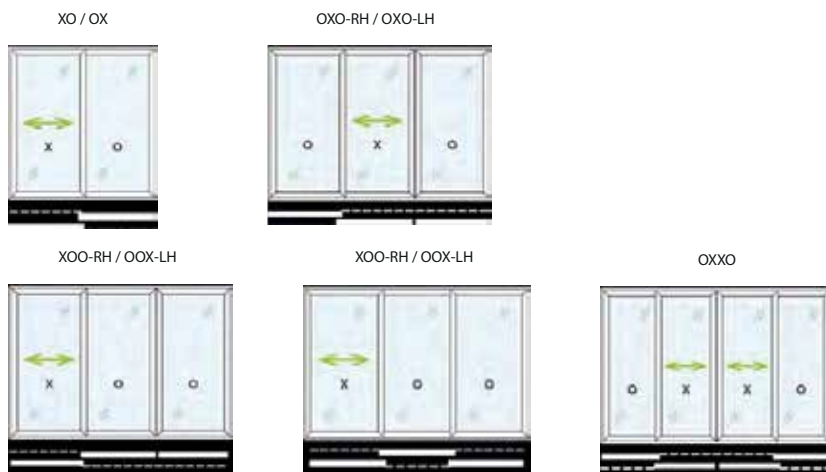

All warranties are subject to approval and in conjunction with Pearl Window Systems terms and conditions of sale.

# Alumina Bi-Fold Doors

## Why choose... The Signature Collection Alumina Bi-Fold Doors?



We take pride in listening to the needs of our customers. Feedback makes it clear that there's a need for aluminium bi-folds for larger and more heavy-duty applications, matching the quality of a uPVC window system.

### ALUMINA BY THE SIGNATURE COLLECTION

This got us thinking – what if there was a way to create a true aluminium door with the same sculptured profile as the The Signature Collection window system? What if we could make it the most thermally efficient aluminium bi-fold out there? And what if we could foil the exterior, so it matched perfectly with uPVC windows?

We did consider multi-material clad hybrid doors – however our feedback showed there are inherent problems with this type of bi-fold. Not only do they require specialist machinery and set-up costs, they can be extremely difficult to fabricate. Furthermore, the warmth of the uPVC is hidden away inside the profile so it's difficult for consumers to see the benefits of such a system. A true aluminium bi-fold was the answer. With these objectives in mind, the The Signature Collection design team embarked on a project to create the first thermally efficient aluminium bi-fold to match a uPVC window system.

The results are clear – Alumina by The Signature Collection breaks new ground with superb strength, high security, low U-values, sculptured lines and a 'warm touch' exterior. And with it, The Signature Collection becomes the first systems company to offer a full suite of fully matching products for any home or building.

### DESIGNED BY EXPERTS

Alumina is more energy efficient than other aluminium bi-fold doors – with U-values as low as 1.2 W/m<sup>2</sup>K.

The Signature Collection were the first to launch a bespoke uPVC bi-folding door system with associated patented hardware and have more than 500 years of industry experience between them – the same team of experts have designed and developed Alumina by The Signature Collection. The latest development from this ground-breaking company and team, Alumina heralds the arrival of a new breed of bi-folding doors.

### COLOURS

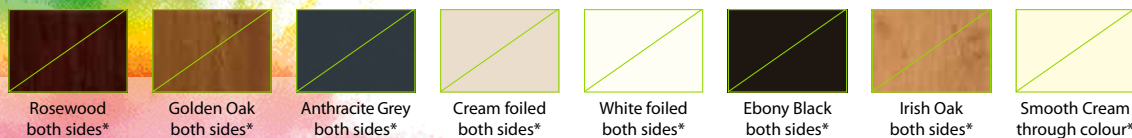

### Bespoke Colour Options



Available  
with fully  
matched PVC  
windows!

Colours marked \* are from our standard collection in featured profile, all other colours are subject to price and availability on application. Please note: colours are for illustration purposes, for an exact example please ask your sales representative for a Renolit swatch sample. Choose from a wide variety of colour options including: White, Rosewood, Cream, Light Oak, Chartwell Green, Grey and classic Ebony Black. The Signature Collection products are also offered in a wide choice of bespoke colours, please see Renolit foil book, (subject to availability and price on application only). Please note: Ebony Black both sides patios and bi-folds are subject to lead time.



- 10 Years Profile Warranty
- Available from an entry level "C" Rated to an "A+" Energy rating
- Your Bi-Fold Plus benefits from being fitted with the most robust locking mechanisms on the market
- Smooth easy action
- Full colour range
- Hook locking with shootbolts
- Secured by Design Security upgrades available on request
- Minimum size 600mm w x 1850mm h (sash opening sizes)
- Maximum size 1200mm w x 2500mm h (sash opening sizes)

### MODLOK™ AND ALUMINA CONFIGURATIONS

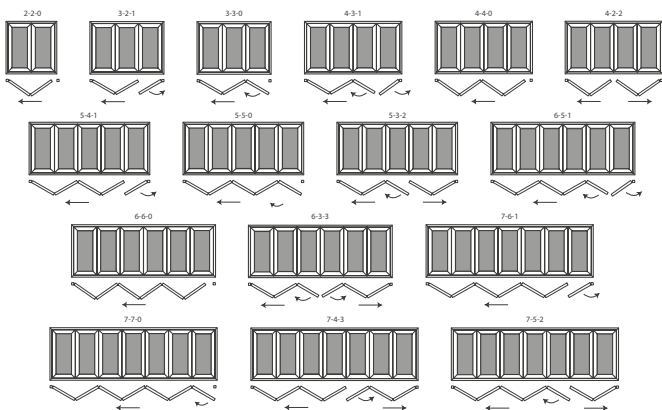

All warranties are subject to approval and in conjunction with Pearl Window Systems terms and conditions of sale.



# Conservatory Roofs

## Why choose... The Signature Collection Conservatory Roof?



The Signature Collection conservatory roof is beautifully designed for modern living.

### DESIGNED FOR TODAY'S CHALLENGES

Our unique thermal twin-walled top caps keep more of the heat inside your conservatory in the winter months, making it less expensive to heat. We've also designed our roof with a centre bar that allows for more height, for the taller people in your family. The unique roof design and engineering results in no holes or gaps for water ingress, so your new room stays leak-free. And the innovative design means that the roof can't ever be taken apart from the outside – making it virtually burglar-proof.

### NOT JUST A CONSERVATORY

Your Signature Collection glazed extension will add extra space to your home – all you need to decide is how you'd like to use it. Maybe you need extra kitchen space? A brick-built extension with The Signature Collection lantern roof will let the natural daylight flood in... add a set of bi-folding doors and you have an open space that's perfect for entertaining in the summer months. Making sure the

children have a safe and light place to play is a great way to use your new space – or why not keep your new room as a quiet, calming adult-only space away from the noise of the main house?

Your Signature Collection Installer will be happy to advise on the best layout and structure for your lifestyle, needs and budget – so open your mind to the possibilities and create your dream space.

### A DESIGN FOR LIFE

Whatever you need, we can design. With The Signature Collection vast range of products, the possibilities are endless. Your glazed extension will become an integral part of your home, so each one is designed with your individual needs in mind.

Whatever your lifestyle, with The Signature Collection you can create the perfect space to enjoy all year round.

### COLOURS

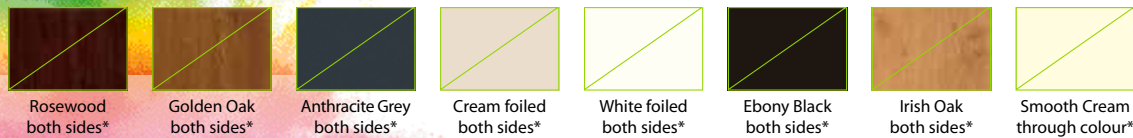

### Bespoke Colour Options



Available with fully matched PVC windows!

Colours marked \* are from our standard collection in featured profile, all other colours are subject to price and availability on application. Please note: colours are for illustration purposes, for an exact example please ask your sales representative for a Renolit swatch sample. Choose from a wide variety of colour options including: White, Rosewood, Cream, Light Oak, Chartwell Green, Grey and classic Ebony Black. The Signature Collection products are also offered in a wide choice of bespoke colours, please see Renolit foil book, (subject to availability and price on application only). Please note: Ebony Black both sides patios and bi-folds are subject to lead time.



- **Lead free** – all profiles are extruded using materials that are 100% lead free
- **Quality assured** – backed with ISO 9001 accreditation for your peace of mind
- **Guaranteed** – all profiles are guaranteed to not warp, split or discolour for a minimum of 10 years
- **EnergyPlus twin walled top caps** are included with every Elevate kit, ensuring a strong and robust fit, and the ultimate thermal efficiency
- **As you would expect, Elevate features The Signature Collections existing conservatory roof innovations** such as the patented Glazing Stop system to avoid slippage
- **British made, Elevate is covered by a 10 year guarantee and supported by a team with more than 500 years' experience of fenestration technology**



All warranties are subject to approval and in conjunction with Pearl Window Systems terms and conditions of sale.



**ROOFS**

# Elevate Lanterns



## Why choose... *The Signature Collection* Elevate Lantern Roof?

To compliment your new Signature Collection windows and doors a range of roof options including a Lantern style roof, designed to match perfectly with other products in The Signature Collection range for a seamless finish – including windows, bi-folding and patio doors.

The lantern-style roof is simple with many colour options to choose from, beautifully designed features slim sightlines and a sleek transition of roof bars allowing in more light for an unobstructed view.

Your new Lantern roof has a patented weather dam to protect against the elements, foiled roofs are supplied with fully foiled components, including top and end caps – giving an aesthetically pleasing finish that perfectly match your Signature Collection Windows and Doors.

### DESIGNED FOR TODAY'S LIVING

The orangery combines cutting edge design with maximum light, allowing you to enjoy the best of both worlds between a conservatory and a traditional extension.

Extremely versatile, each elevation allows any combination of masonry, windows and doors, so your orangery is truly bespoke to you. Why not add mood lighting under the eaves for a truly contemporary design?

Lantern roofs can also be added to any large conservatory, boosting the height of the overall construction and increasing the feeling of interior space and light.

You can incorporate openers to increase ventilation, in addition to decorative glazing panels to further personalise your design.

### COLOURS

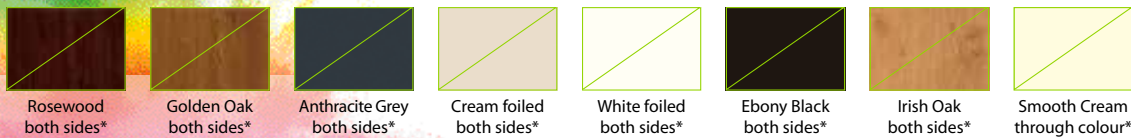

### Bespoke Colour Options



Available with fully matched PVC windows!

Colours marked \* are from our standard collection in featured profile, all other colours are subject to price and availability on application. Please note: colours are for illustration purposes, for an exact example please ask your sales representative for a Renolit swatch sample. Choose from a wide variety of colour options including: White, Rosewood, Cream, Light Oak, Chartwell Green, Grey and classic Ebony Black. The Signature Collection products are also offered in a wide choice of bespoke colours, please see Renolit foil book, (subject to availability and price on application only). Please note: Ebony Black both sides patios and bi-folds are subject to lead time.



- **Lead free** – all profiles are extruded using materials that are 100% lead free
- **Quality assured** – backed with ISO 9001 accreditation for your peace of mind
- **Guaranteed** – all profiles are guaranteed to not warp, split or discolour for a minimum of 10 years
- **Sizes available up to a maximum of 2.4m x 5.4m**
- **EnergyPlus twin walled top caps are included with every Elevate kit, ensuring a strong and robust fit, and the ultimate thermal efficiency**
- **As you would expect, Elevate features The Signature Collections existing conservatory roof innovations such as the patented Glazing Stop system to avoid slippage**
- **British made, Elevate is covered by a 10 year guarantee and supported by a team with more than 500 years' experience of fenestration technology**



ROOFS

All warranties are subject to approval and in conjunction with Pearl Window Systems terms and conditions of sale.

THE  
*Signature*

TM  
COLLECTION

WINDOWS & DOORS  
WITH EXTENDED WARRANTIES

- Casement Windows
- Tilt and Turn Windows
- Flush Sash Windows
- Bi-Folding Doors
- Patio Doors
- French Doors
- Residential Doors
- Conservatories



**CORGI**  
**Fenestration**



0800 014 2769

[sales@thesignaturecollections.com](mailto:sales@thesignaturecollections.com)

[www.thesignaturecollections.com](http://www.thesignaturecollections.com)